

## Product Datasheet



The global certified TLD-810-C is a dual stage extremely wide input smart LED driver. 10kV surge protection level, 100khour long life and 7-year warranty provide high confidence to luminaire users. It supports not only traditional 4-in-1 control, but also DALI2.0 and other protocols. NFC and cable programming are both available for users. All around protections including digital OTP (internal and external by NTC) with auto-recovery secure 24hour non-stop operation for luminaires.



- Features .....2
- Model List .....2
- Technical Data .....3
- Safety/EMC Compliance .....4
- Dimming .....4
- Programming .....6
- Lifetime vs. Case Temperature .....8
- Power Factor vs. Load .....8
- THD vs. Load .....9
- Efficiency vs. Load (18A Model) .....9
- Inrush Current .....10
- Dielectric Strength .....10
- Tc Point .....10
- Packaging Information .....11
- Mechanical Design .....12
- Output Operation Range .....21
- Revision History .....23

## ■ Features

- Absolute Supply Voltage: 200-528Vac or 250-740Vdc
- Great Surge Immunity 10kV
- 96% Efficiency Max.
- Customized Endcap
- Low Inrush Current
- Active Daisy Chain and Master Mode
- 100,000Hour Life @ Tc=75°C
- 7 Year Warranty @ Tc<=75°C
- Airset™ NFC Programmability
- +/-2% Output Current Accuracy
- Isolated 0-10V/PWM/Time/DALI2.0 Dimmable
- Dim Off with 1.5W Standby Power
- 12V 300mA Auxiliary Power to Power Controllers and Fans (Optional)
- UL Class P, ENEC/CB/CCC SELV Output
- Global Certified Model Available
- Safety according to EN 61347-1, 61347-2-3, 61347-2-13, 62384

## ■ Model List

Model Number	Input Voltage Range	Output Power	Output Voltage	Full Power Settable Current Min	Full Power Settable Current Max	Certification
TLD-810-C18A-XYZ	180-528Vac	810 W	30-56Vdc	14.5A	18A	UL/FCC/ENEC/CCC /CB/RCM/ EAC/CE
TLD-810-C860-XYZ	180-528Vac	810 W	56-133Vdc	6A	8.6A	
TLD-810-C600-XYZ	180-528Vac	810 W	80-190Vdc	4.2A	6A	
TLD-810-C420-XYZ	180-528Vac	810 W	114-222Vdc	3.6A	4.2A	

XY=	Dimming Method	Programmable	12Vaux	Dim-off
NN	-	-	-	-
DN	0-10V	Cable	-	<b>No Dim-off as default status, programmed to have Dim-off</b>
EN	0-10V	Cable	300mA	√
TR	Time/Set Current	NFC Wireless	-	-
DR	0-10V	NFC Wireless	-	<b>No Dim-off as default status, programmed to have Dim-off</b>
ER	0-10V/PWM/Time	NFC Wireless	300mA	√
AR	DALI2.0	NFC Wireless	-	√

Z = U, UL cable with ground wire (green)    S, VDE cable/Class I    D, VDE cable/Class II

**Note:** See the **Output Operation Range Section** for programmable model details

## ■ Technical Data

Input Voltage	180-528Vac or 250-740Vdc
Input Frequency	47~63Hz
Power Factor	>0.9@60-100%load, refer to PF vs. Load curve
THD	<15%@60-100%load, refer to THD vs. Load curve
Input Current	3.5Amax@277Vac & Full-Load, 2Amax@480Vac & Full-Load
Inrush Current	See Inrush Current Section in the datasheet
Leakage Current	1mA max @277Vac 60Hz, UL8750,0.75mA max @220Vac 50Hz, IEC61347-1
Input Under Voltage	Shut down and auto-restart
Surge Protection	Line to line 6kV, line to ground 10kV, IEC 61000-4-5
Current Accuracy	±2%Io for programmable model, ±5%Io for non-programmable model
Ripple Current	Ip-p:5%Io max
Setup Time	1.2s max
Overshoot	10% Io max & LED Load
Output Over Voltage	110% Vomax, typ.
Short Circuit	Auto recovery. The output recovers when short is removed.
Over Temperature	Lower the output current when $T_c \geq 105 \pm 10^\circ\text{C}$ ; Auto Recovery When $T_c \leq 70 \pm 10^\circ\text{C}$
Auxiliary Power (Vaux)	12V+/-5%, 300mA max
Operating Temperature	Case Temperature $T_c = -40^\circ\text{C} \sim +90^\circ\text{C}$ ; 10%RH~100%RH
Storage Temperature	$-40^\circ\text{C} \sim +85^\circ\text{C}$ ; 5%RH~100%RH
MTBF	$\geq 320,000$ hours, $75^\circ\text{C}$ case temperature (MIL-HDBK-217F)
Lifetime	$\geq 100,000$ hours, $75^\circ\text{C}$ case temperature, refer to life vs. $T_c$ curve
Case Temperature	$90^\circ\text{C}$ max, marked in the $T_c$ point of label
Dimensions	13.22x3.54x1.63 by inch (body), 14.29x3.54x1.63 by inch (endcaps included) 336x 90 x 41.5 by mm (body), 363 x 90 x 41.5 by mm (endcaps included)
Net Weight	2600g
Packing	See Package Information Section in the datasheet

Notes: Unless specified, all the test results are measured in  $25^\circ\text{C}$  room temperature.

## ■ Safety/EMC Compliance

Safety Standard	Description
UL8750	Light emitting diode(LED) equipment for use in lighting products
UL1012	Power units other than class 2
IEC 61347-1	Lamp control gear Part 1: general and safety requirements
IEC 61347-2-13	Lamp control gear Part 2-13: particular requirement for d.c. or a.c. supplied electronic control gear for LED modules
EMI Standards	Description
IEC 55015	Conducted emission test & radiated emission test
IEC 61000-3-2	Harmonic current emissions; Class C
IEC 61000-3-3	Voltage fluctuations & flicker
FCC Part 15	ANSI C63.4:2009 Class B
EMS Standards	Description
IEC 61000-4-2	Electrostatic discharge (ESD): 8 kV air discharge, 4 kV contact discharge
IEC 61000-4-3	Radio frequency electromagnetic field susceptibility test (RS)
IEC 61000-4-4	Electrical fast transient (EFT)
IEC 61000-4-5	Surge immunity test
IEC 61000-4-6	Conducted radio frequency disturbances test (CS)
IEC 61000-4-8	Power frequency magnetic field test
IEC 61000-4-11	Voltage dips
IEC 61547	Electromagnetic immunity requirements applies to lighting equipment

## ■ Dimming

Parameter	Min.	Typ.	Max.
Vdim Sourcing Current	100uA	150uA	200uA
Vdim Allowed Input Voltage	-20 V		20 V
0-10V Dimming Range	10% (Vdim=1V)	Linear	100% (Vdim=9~10V)
PWM Dimming Range	10% (Duty=10%)	Linear	100% (Duty=90-100%)
Dim off threshold	0.4V or 4%	0.5V or 5%	0.6V or 6%
Dim on threshold	0.6V or 6%	0.7V or 7%	0.8V or 8%
PWM High	3.8V		10V
PWM Low	0V		0.6V
PWM Frequency	300Hz		2kHz
External PWM Controller Current Sinking Capability	300uA		
DALI Interface Standard	IEC62386, part 101,102,207		
DA1,DA2 High Level	9.5	16	22.5
DA1,DA2 Low Level	-6.5	0	6.5
DA1,DA2 Current	0		2mA

- Dimming Curve

a. Without dim-off

0-10V Dimming Curve

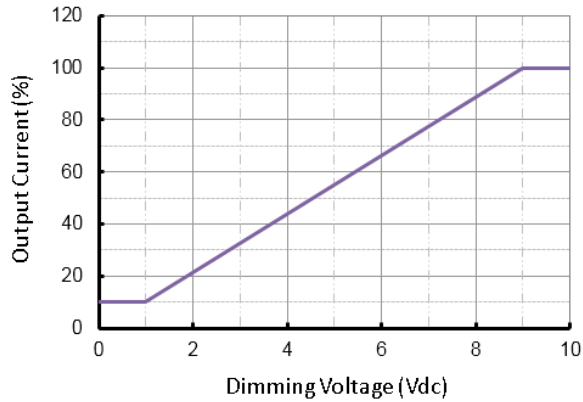

PWM Dimming Curve

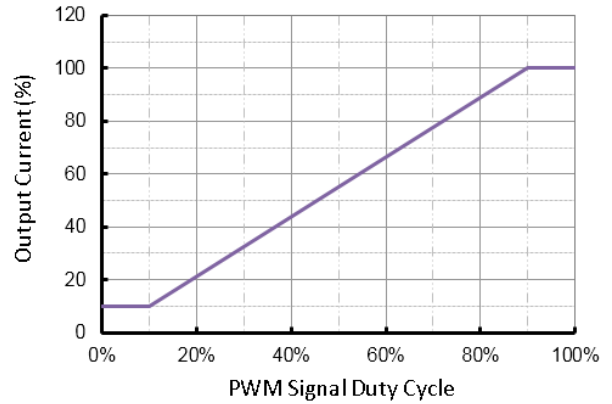

b. With dim-off

0-10V Dimming Curve

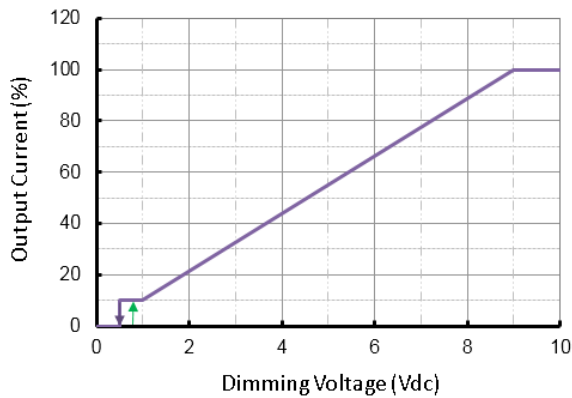

PWM Dimming Curve

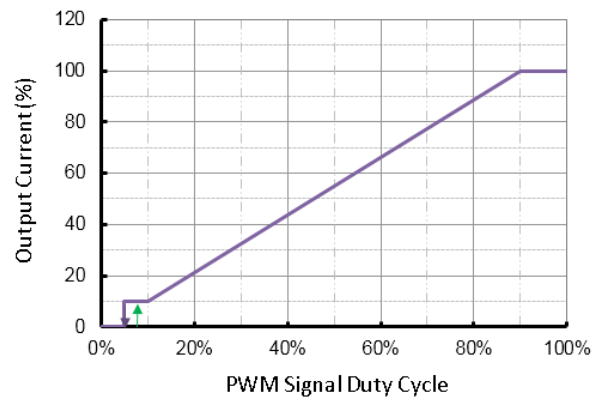

- Dimming Wiring

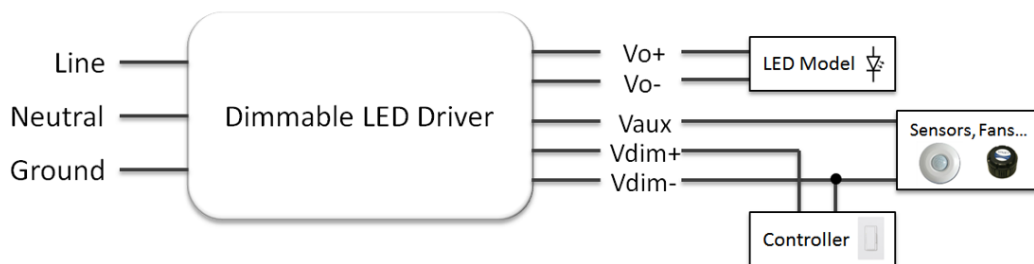

## ■ Programming

### - NFC Programming by PC/Laptop



- Download PC Software at <https://www.upowertek.com/download-2/>
- Click Upowertek Programming Utility.exe
- The GUI start and notify you the programming mode (cable programming or NFC programming)
- Click "NFC" button if it's not NFC programming mode.

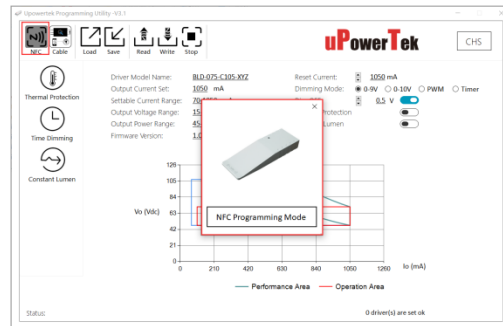
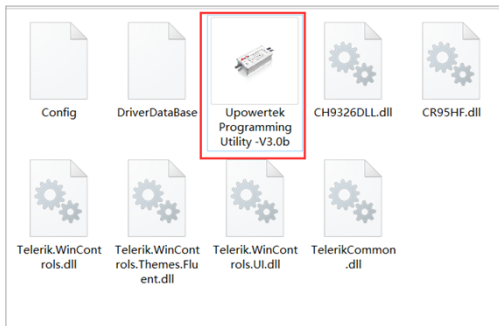

### - NFC Programming by Smartphone

- Download Android APP at <https://www.upowertek.com/download-2/>
- Only available on Android cellphone (iPhone is not supported)
- The cellphone should have NFC function and make sure it is enabled.

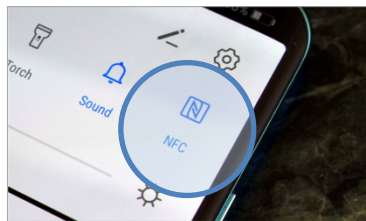

- Turn on NFC switch of cellphone, then open the APP by icon below.



uPowerTek  
Airset

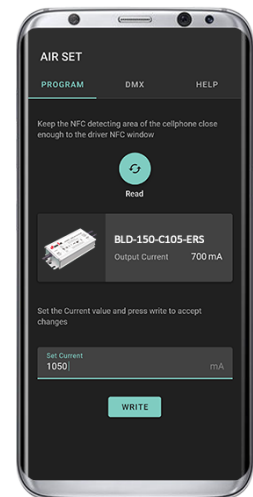

- Cable Programming



- Download PC Software at <https://www.upowertek.com/download-2/>
- Click Upowertek Programming Utility.exe
- The GUI start and notify you the programming mode (cable programming or NFC programming)

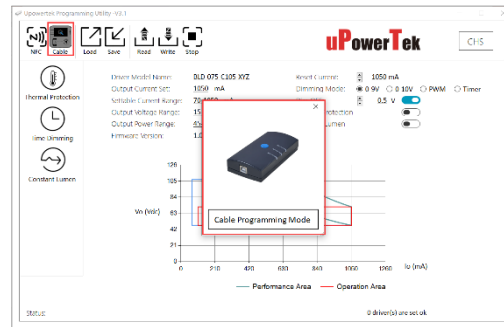
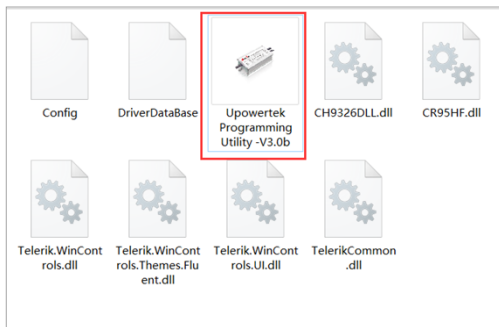

- Click "Cable" button if it's not cable programming mode.
- Connect the Vdim+ and Vdim- wires to the right ones (the same color) of the programmer.

- Please contact with us for product user manual and more information such as:

- Output Lumen Compensation
- Luminaire Thermal Protection by External NTC (with extra cable)
- Dimming Curve Customization (dim off threshold, minimum dimming level, maximum dimming voltage etc.)
- Adjustable Startup Time
- Time Dimming (adaptive mid-night, percentage, etc.)
- Customized Control Protocol

## ■ Lifetime vs. Case Temperature

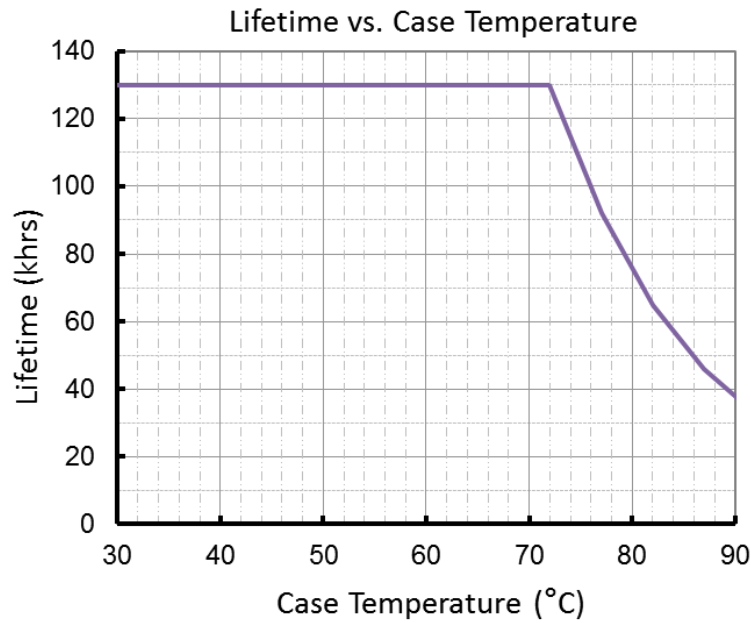

(End of Life: Maximum Failure Rate=10%)

## ■ Power Factor vs. Load

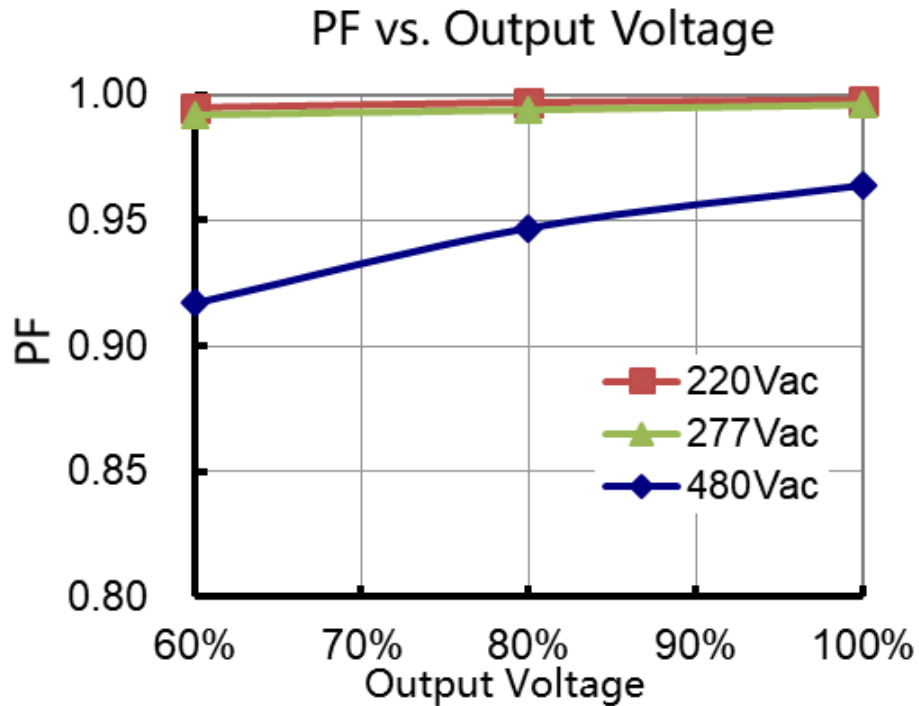



## THD vs. Load

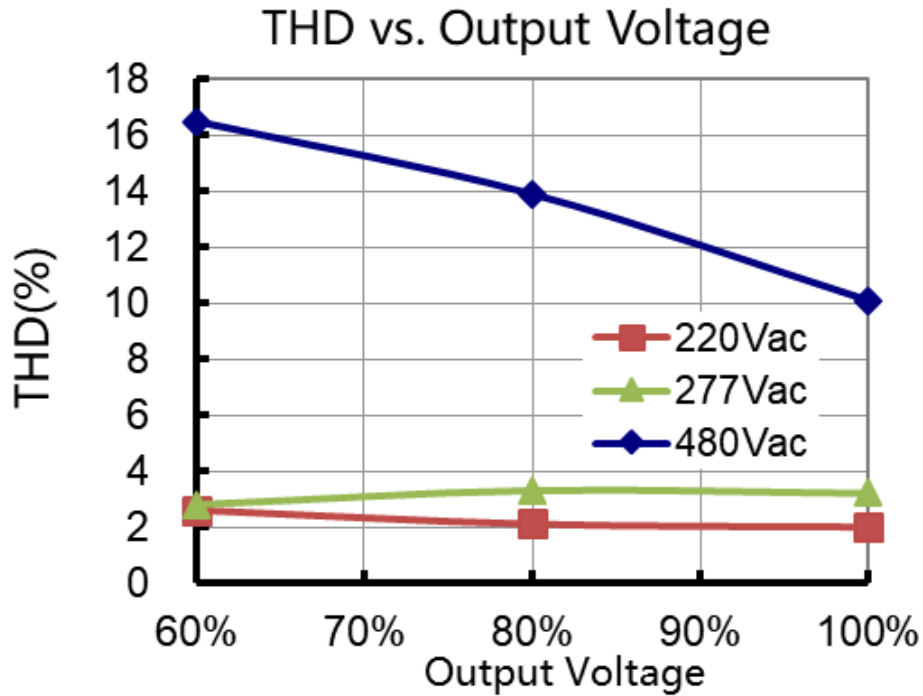

## Efficiency vs. Load (18A Model)

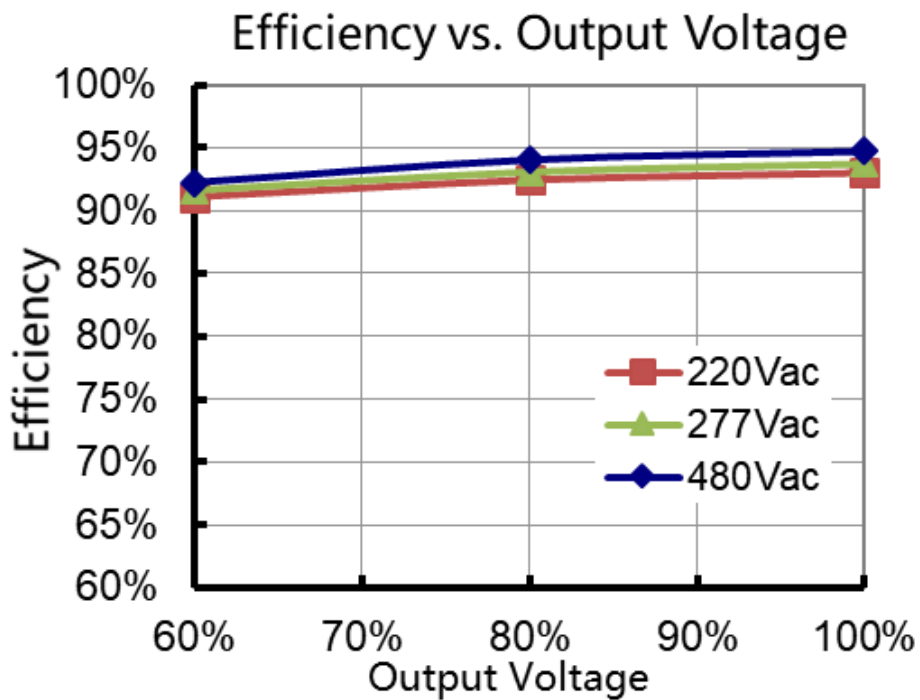

## Inrush Current

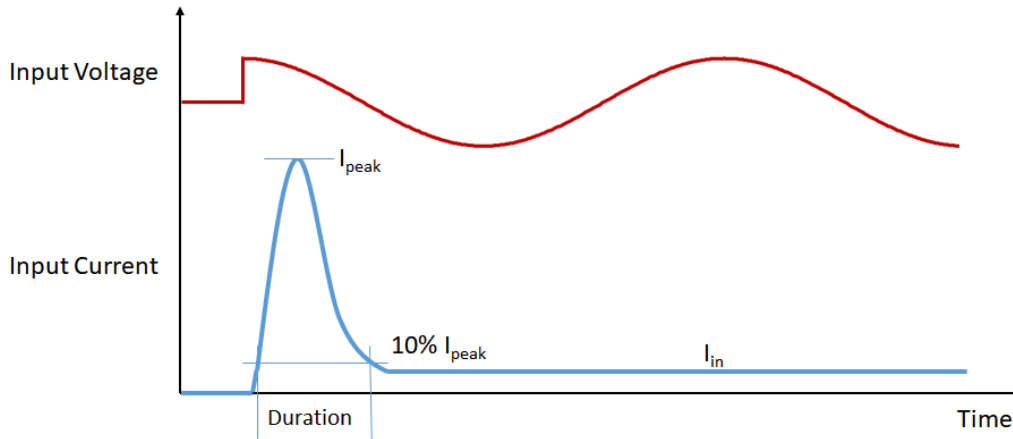

Input Voltage	$I_{peak}$	Duration
277Vac	7.1A	19.3mS
380Vac	10.5A	14.1mS
480Vac	13.3A	15.4mS

Please contact with us for MCB calculation and waveforms.

## Dielectric Strength

Unit: Vac	Input	Output	Dimming	Case
Input	-	3920	3920	1960
Output	3920	-	1960	1960
Dimming	3920	1960	-	1960
Case	1960	1960	1960	-

## Tc Point

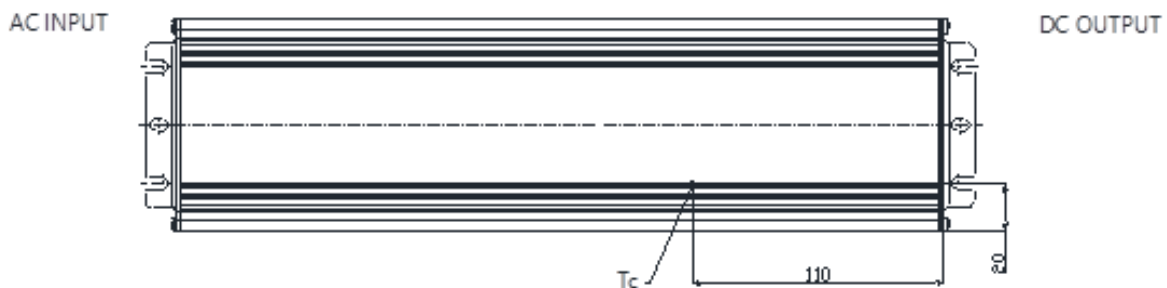

## ■ Packaging Information

Typical Carton Dimension(L×W×H)	490×280×130 mm
Positioning plate	2pcs/carton
Shield Board	1pcs/carton
LED Drivers	4pcs/carton

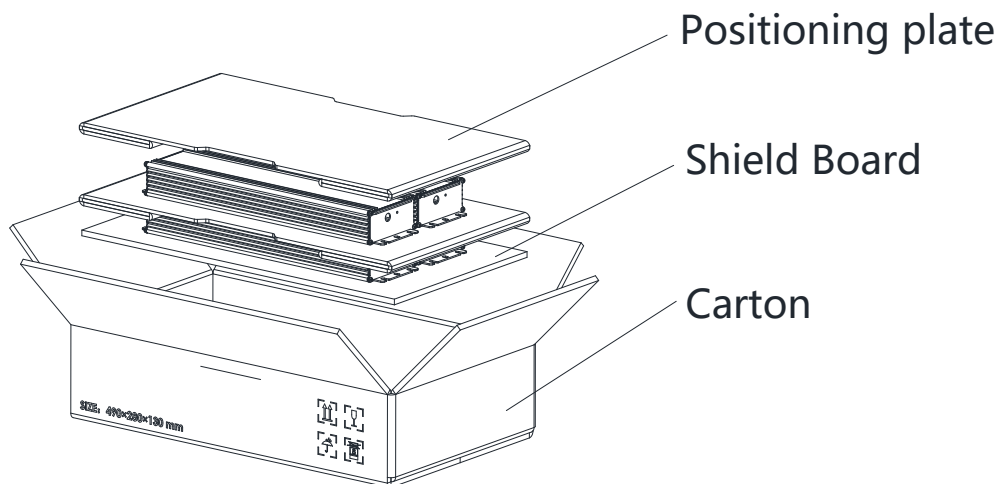

## Mechanical Design

### TLD-810-Cxxx-NN/TRU (UL Cable)

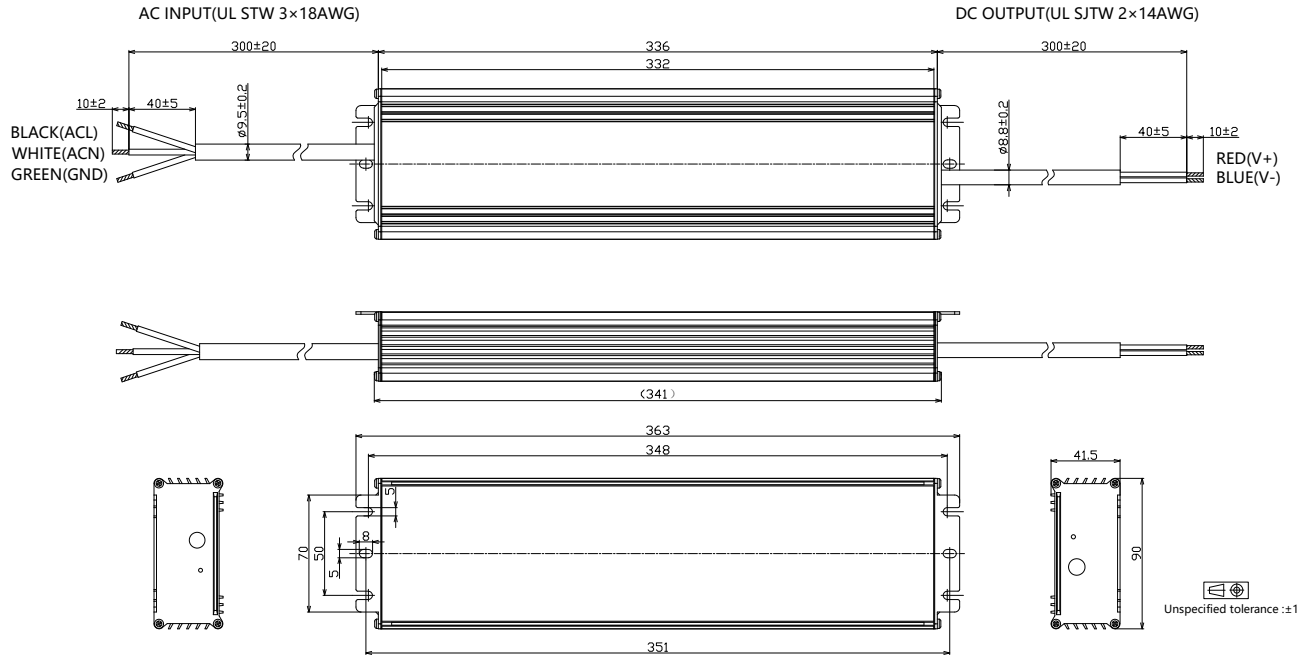

### TLD-810-Cxxx-DN/DRU (UL Cable)

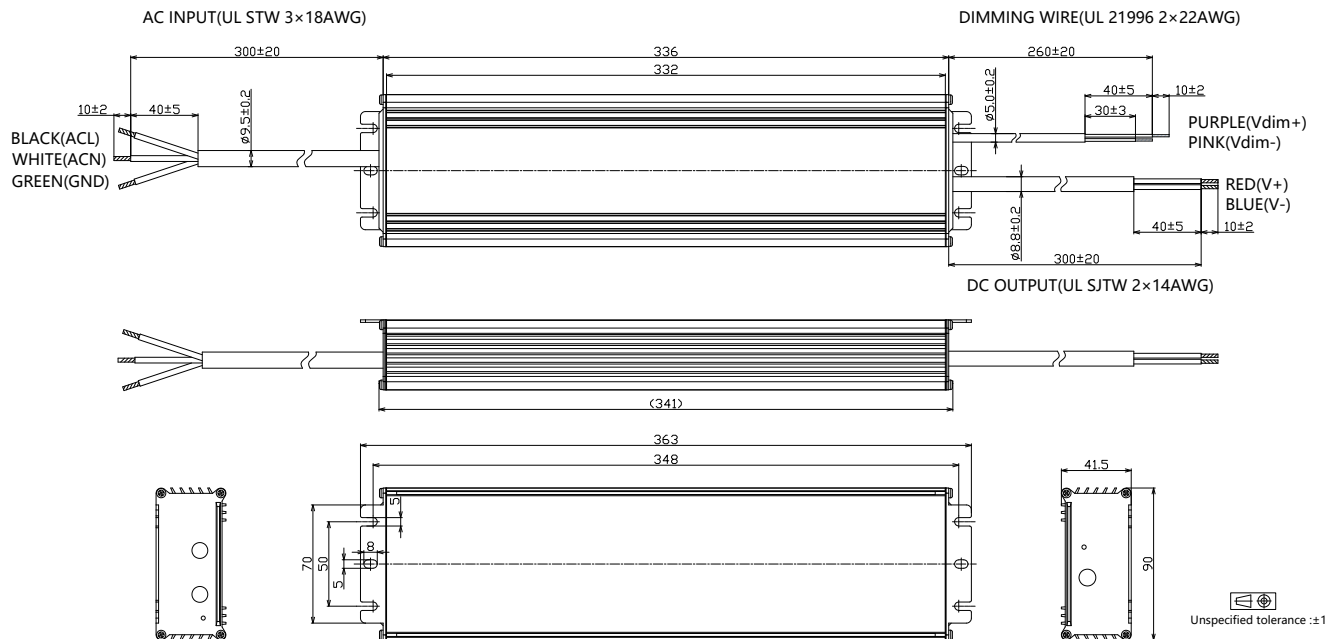

- TLD-810-Cxxx-ERU (UL Cable)

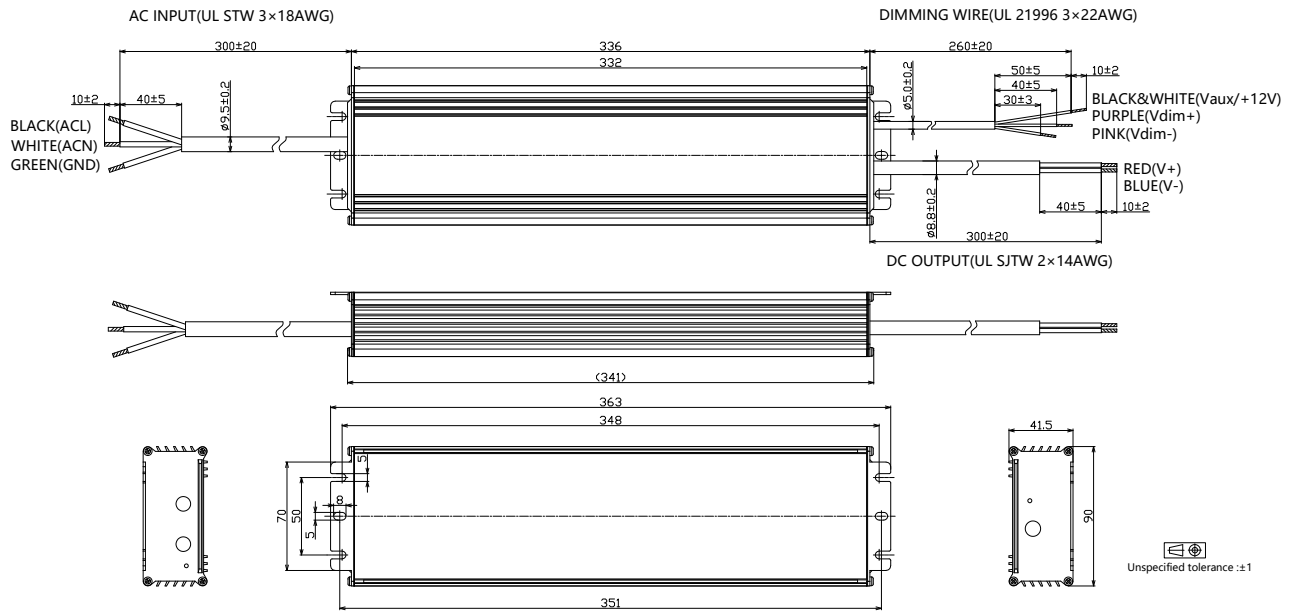

- TLD-810-Cxxx-ARU (UL Cable)

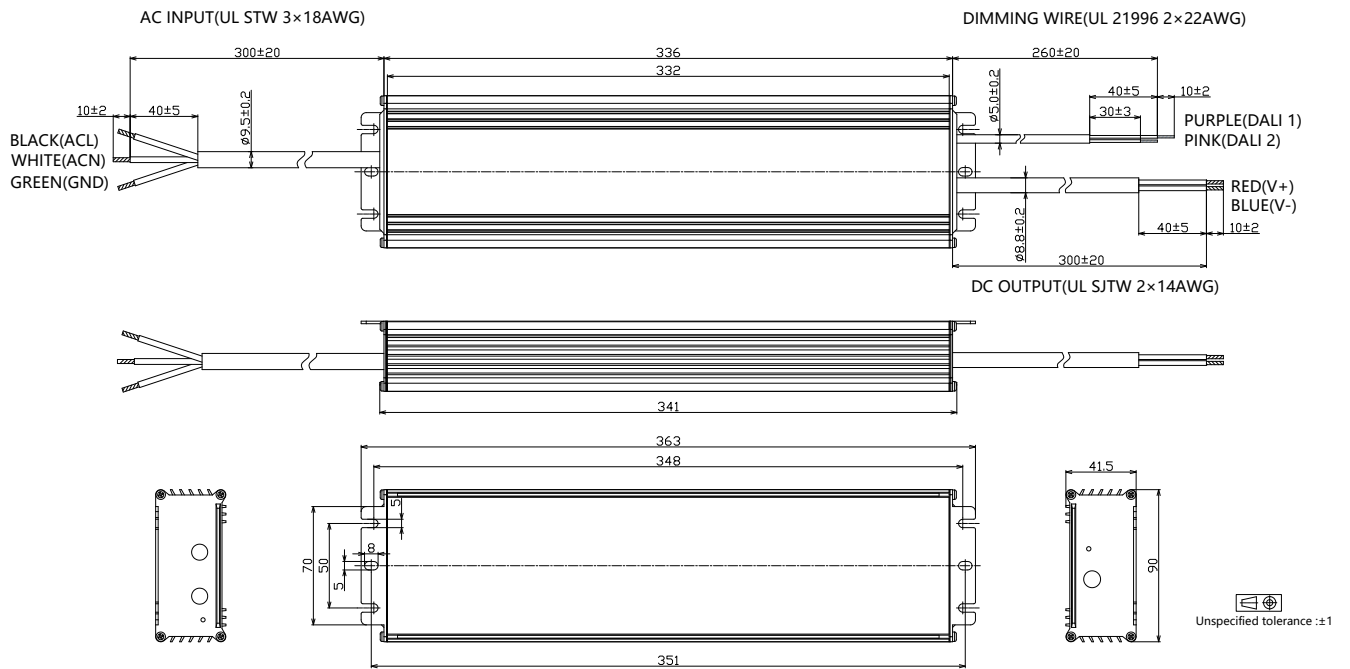

- TLD-810-Cxxx-MRU (UL Cable)

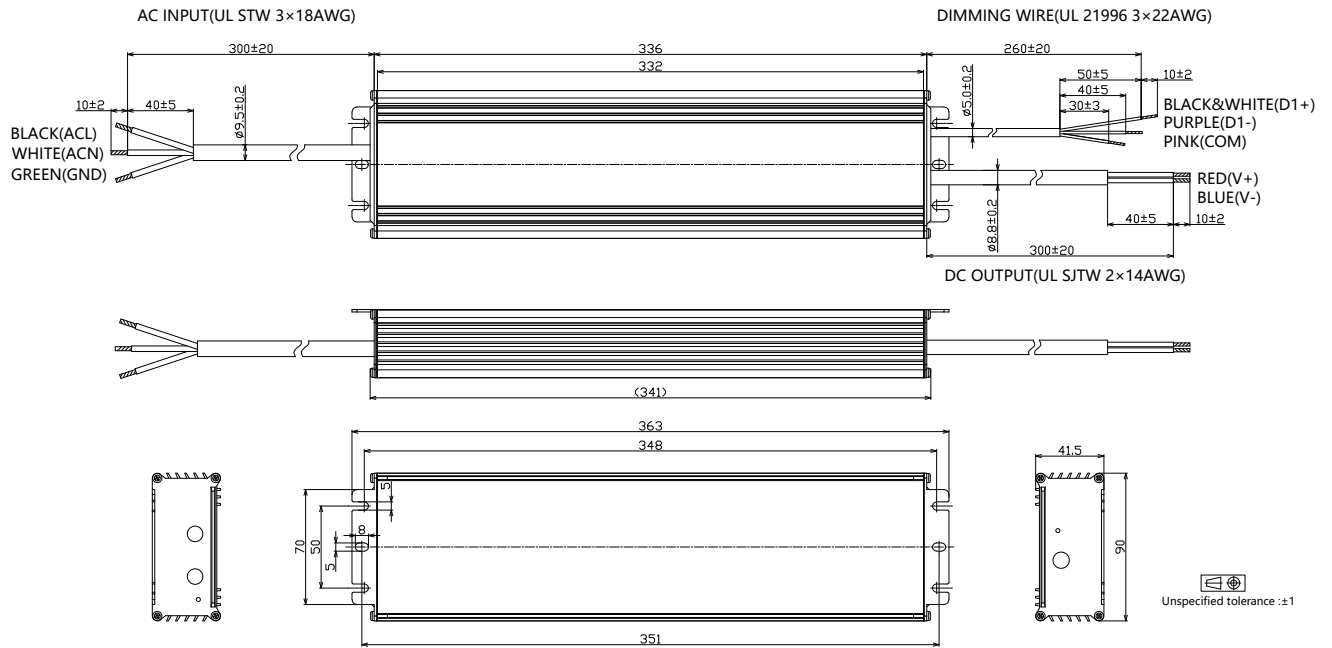

- TLD-810-Cxxx-NN/TRS (VDE CABLE, MODELS WITH HIGHER THAN 60V OUTPUT VOLTAGE)

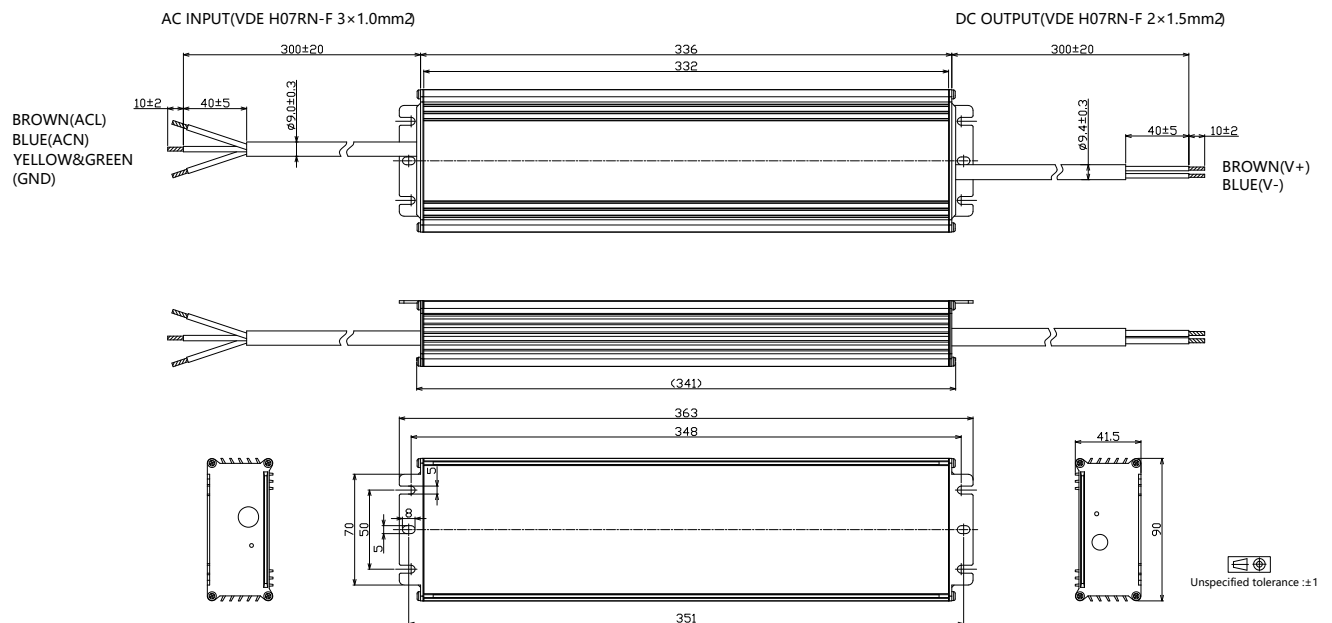

### 810W, 200-480Vac Input, Long Life High Quality Driver

- TLD-810-Cxxx-DN/DRS (VDE CABLE, MODELS WITH HIGHER THAN 60V OUTPUT VOLTAGE)

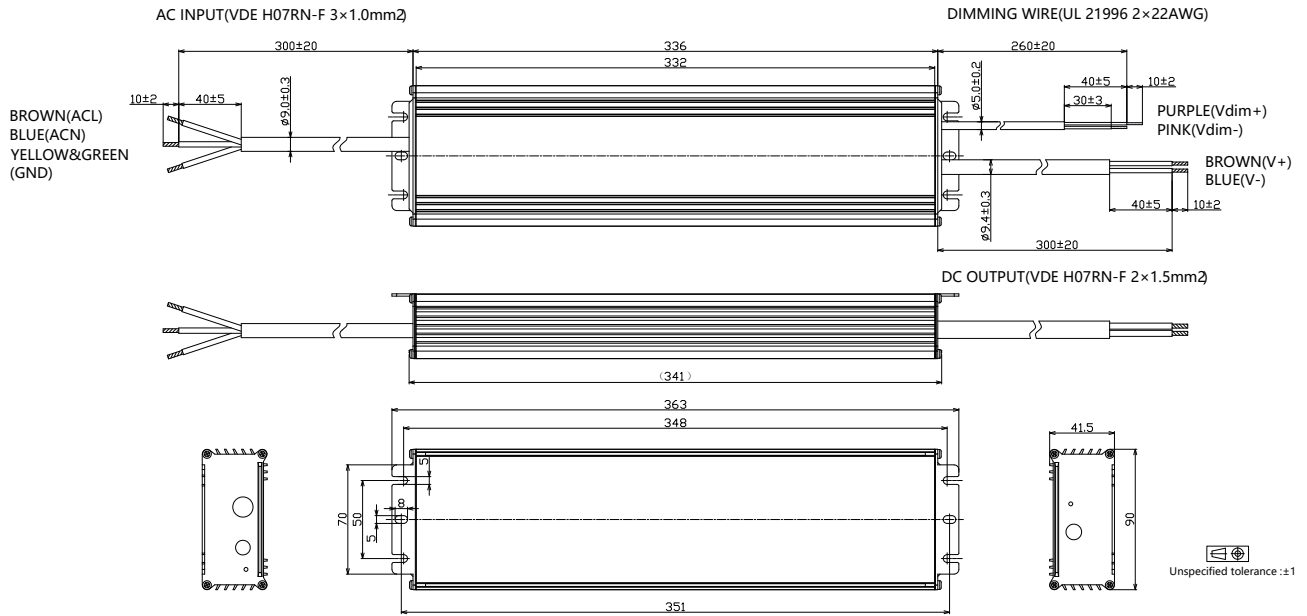

- TLD-810-Cxxx-EN/ERS (VDE CABLE, MODELS WITH HIGHER THAN 60V OUTPUT VOLTAGE)

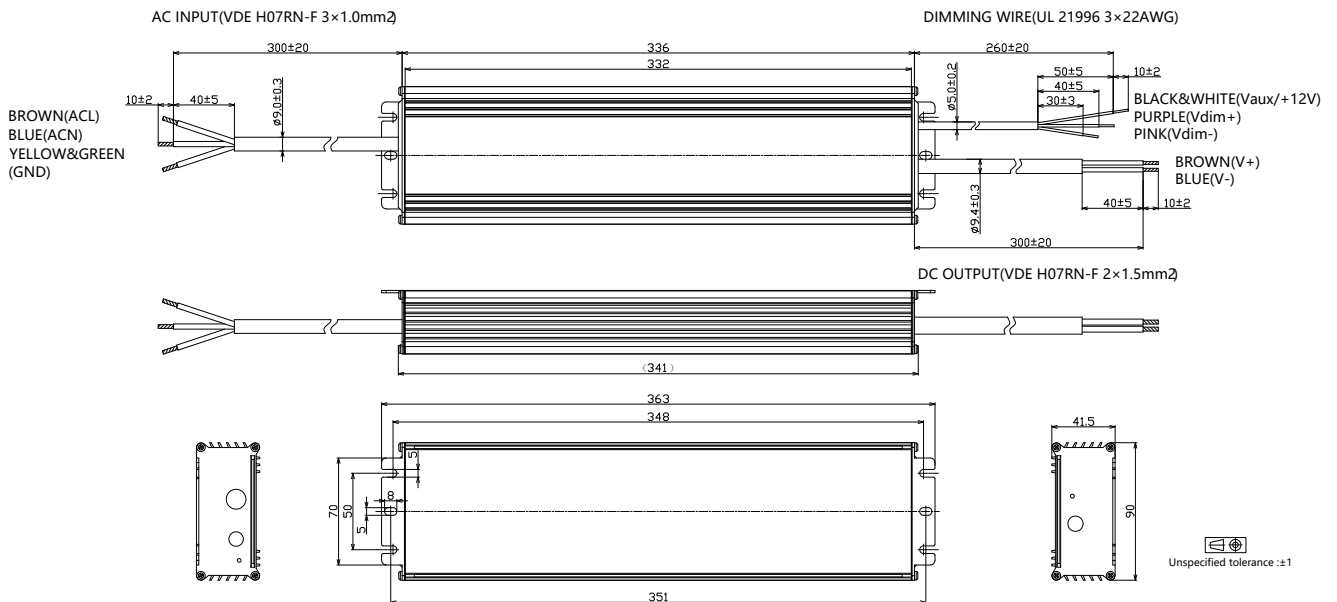

### 810W, 200-480Vac Input, Long Life High Quality Driver

- TLD-810-Cxxx-ARS (VDE CABLE, MODELS WITH HIGHER THAN 60V OUTPUT VOLTAGE)

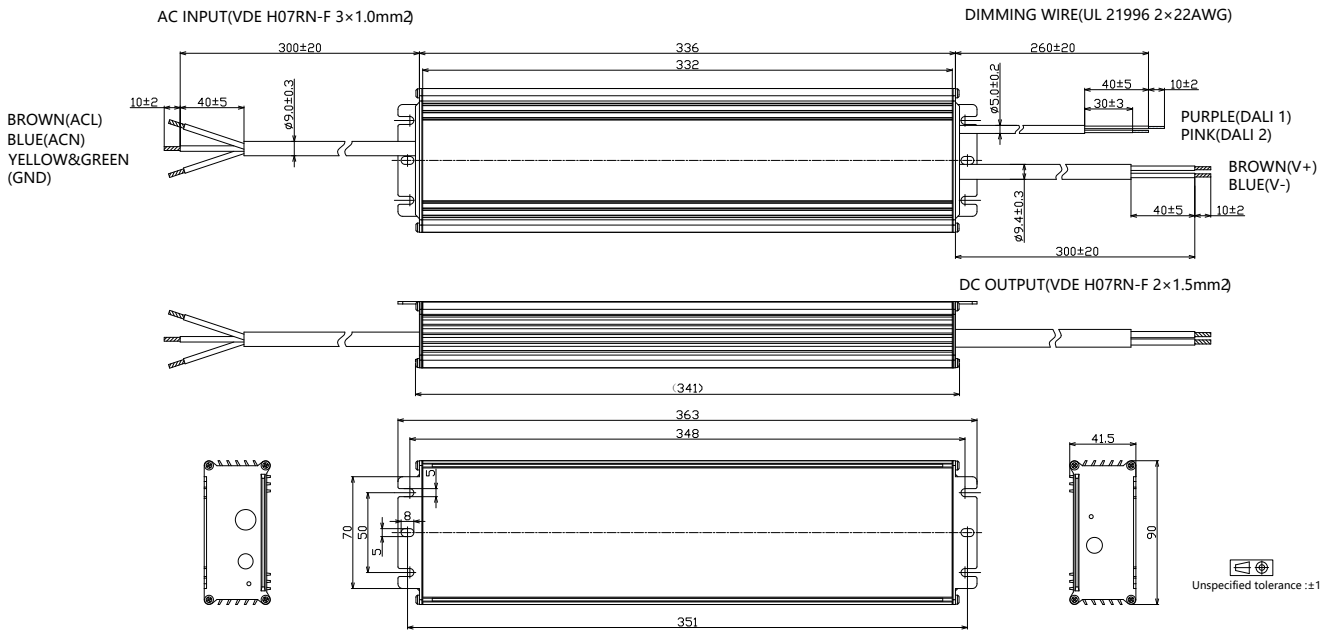

- TLD-810-Cxxx-MRS (VDE CABLE, MODELS WITH HIGHER THAN 60V OUTPUT VOLTAGE)

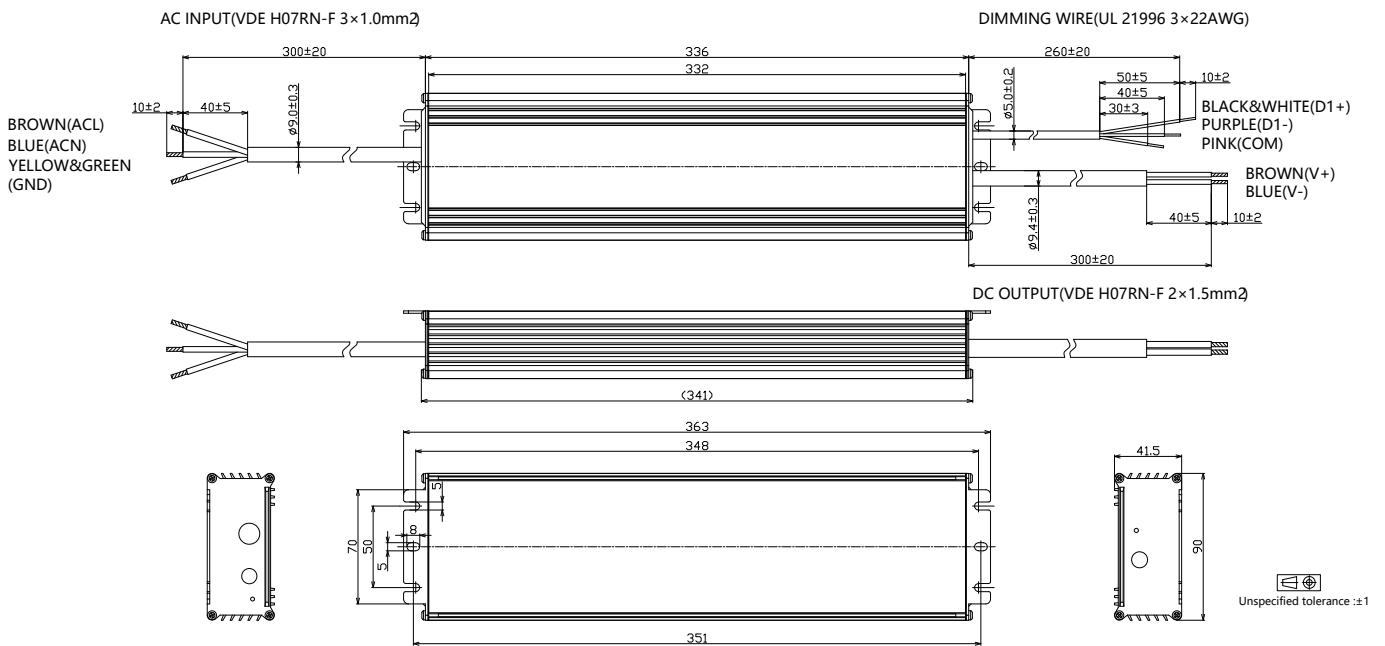



- TLD-810-Cxxx-NN/TRS (VDE CABLE, MODELS WITH LESS THAN 60V OUTPUT VOLTAGE)

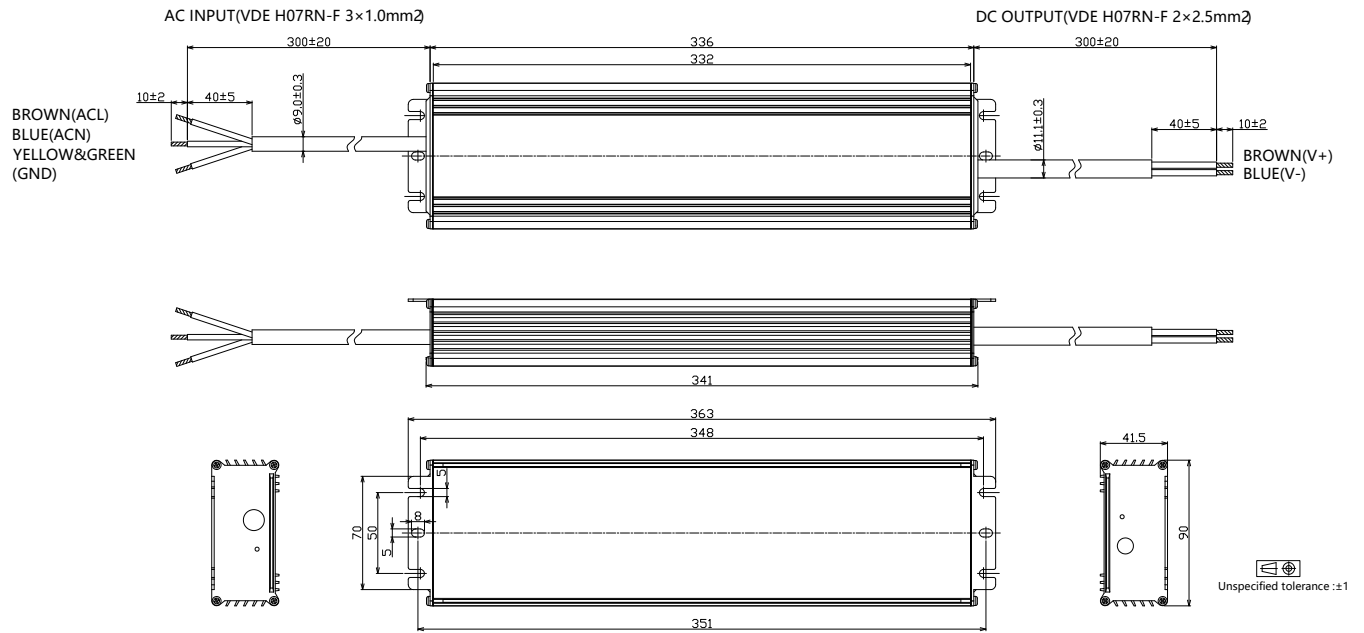

- TLD-810-Cxxx-DN/DRS (VDE CABLE, MODELS WITH LESS THAN 60V OUTPUT VOLTAGE)

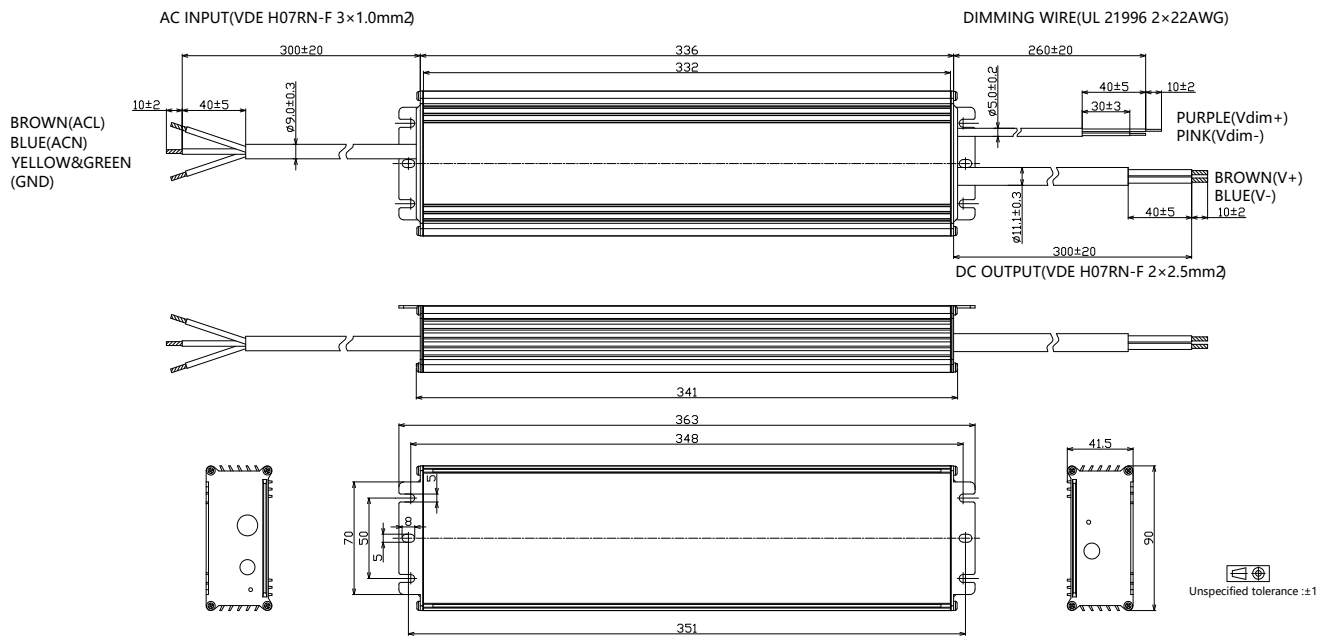

- TLD-810-Cxxx-EN/ERS (VDE CABLE, MODELS WITH LESS THAN 60V OUTPUT VOLTAGE)

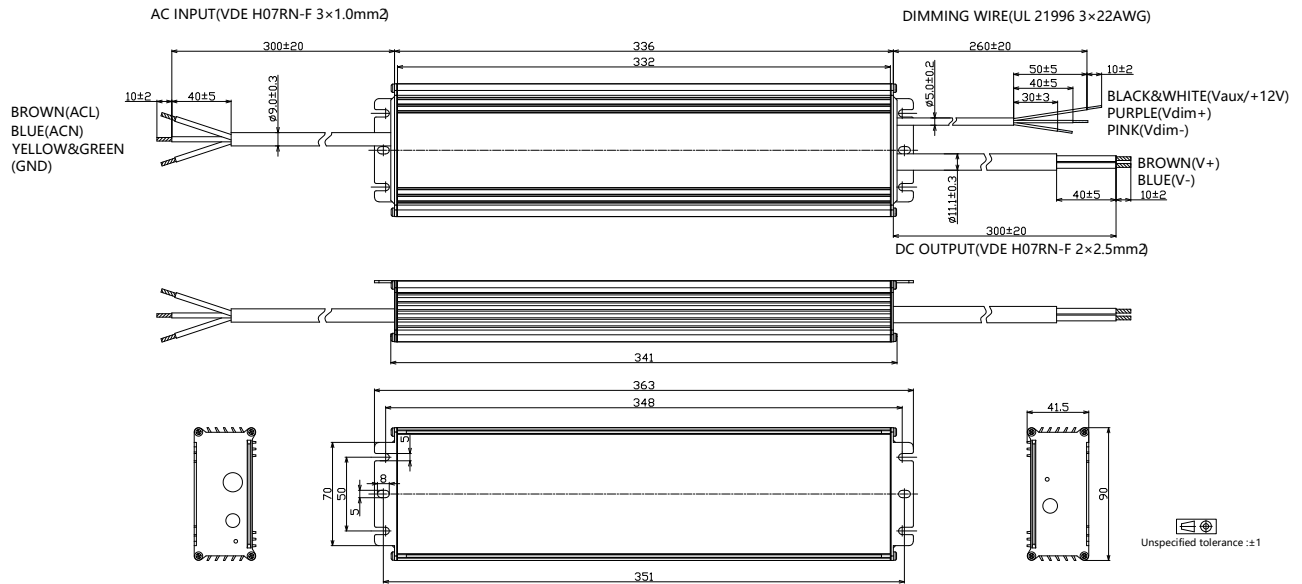

- TLD-810-Cxxx-ARS (VDE CABLE, MODELS WITH LESS THAN 60V OUTPUT VOLTAGE)

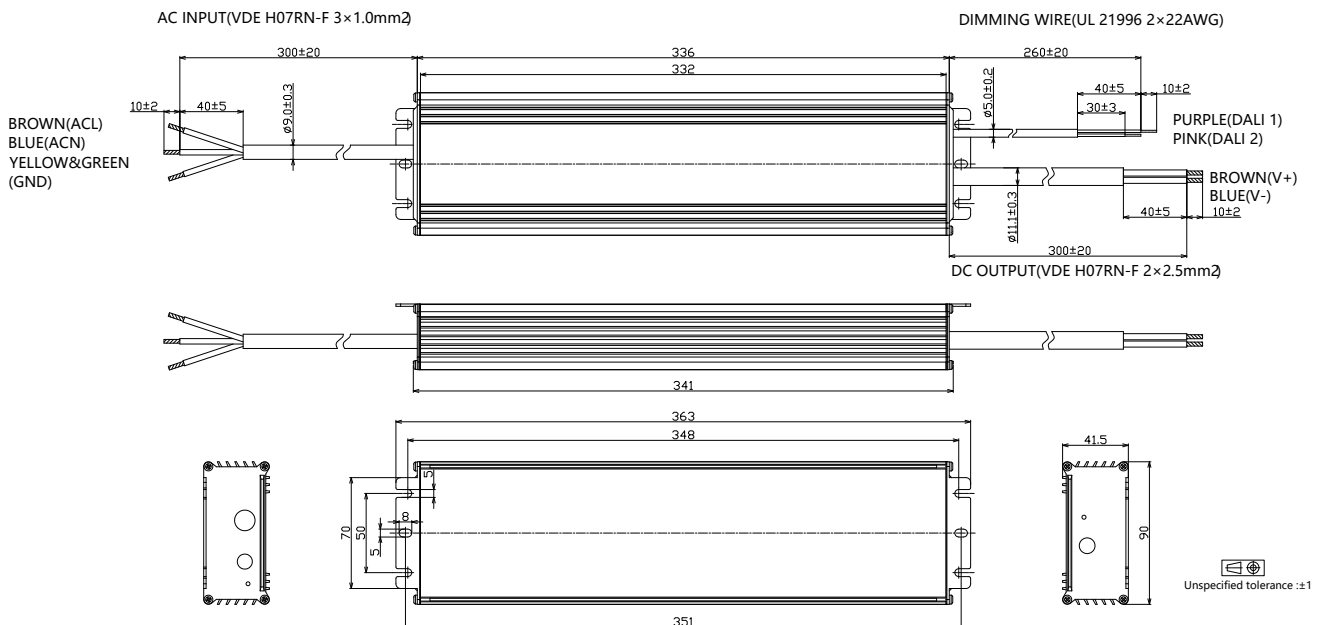

- TLD-810-Cxxx-MRS (VDE CABLE, MODELS WITH LESS THAN 60V OUTPUT VOLTAGE)

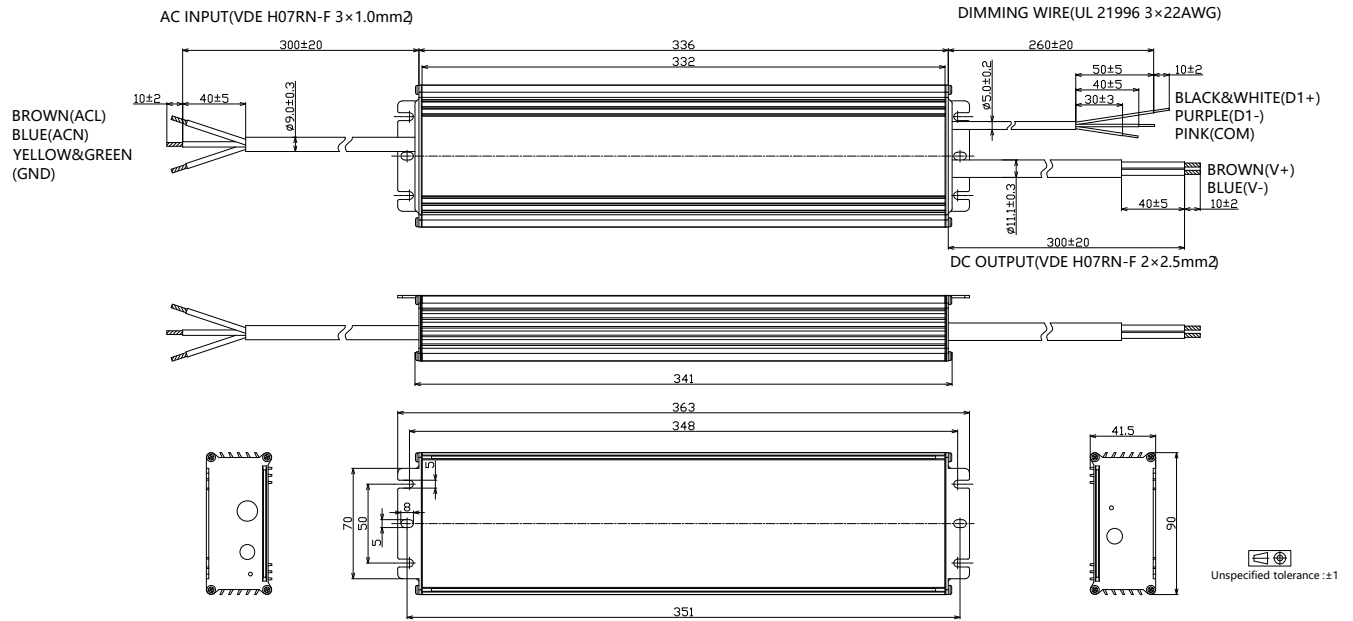

## 810W, 200-480Vac Input, Long Life High Quality Driver

- Customized Functional End Cap Version

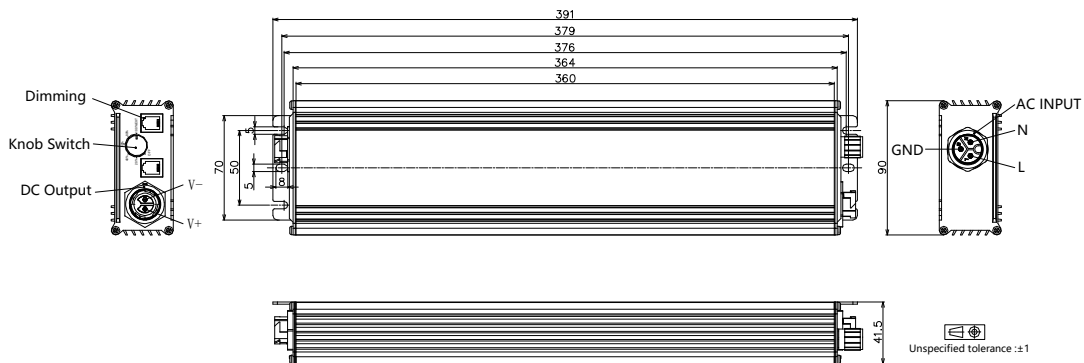

- Add suffix #abcd00 to the end of part number to indicate different configuration. Please refer to product application note AN06 or contact with us for more like **active daisy chain, master mode and button dimming** etc.

Item	Value Definition	Description
Input	a	F: M19 waterproof connector P: C14 plug N: Same cable as standard version
Output	b	F: M19 waterproof connector, 2 pin N: Same cable as standard version
Dimming	c	F: M12 waterproof connector R: RJxx (xx=25, 14, 12, 11) connector x 2 S: 3.5mm multi-media plug N: Same cable as standard version
Knob	d	K: Knob with steps B: Knob without steps N: No knob

- RJ25 Pin Description (can be customized according to control system)

Pin	Description
1,6	12V Aux-power
2,5	Dim+
3,4	Dim-/RTN

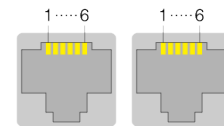

- Knob Description

Position	Description
100%/EXT	If there is no external control, 100% output. If there is external control, output is controlled by external signal.
Off,20%,40%,60%,80%	External signal invalid.

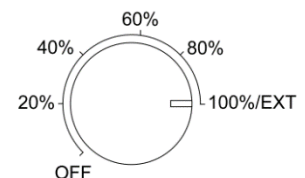

**■ Output Operation Range**

Model	Typical Set Output Current (mA)	Max Output Power (W)	Output Voltage Min (V)	Output Voltage Max(V)	Minimum Dimming Current (mA)
-C18A	18000	810	30	45	1800
	17000	810	30	48	1700
	16000	810	30	51	1600
	15000	810	32	54	1500
	14500	810	34	56	1450
	14000	782	34	56	1450
	12000	670	34	56	1450
	10000	559	34	56	1450
	...	...	...	...	...
	1450	80	34	56	1450

Model	Typical Set Output Current (mA)	Max Output Power (W)	Output Voltage Min (V)	Output Voltage Max(V)	Minimum Dimming Current (mA)
-C860	8600	810	56	93	860
	8500	810	56	94	850
	8400	810	57	95	840
	8200	810	59	98	820
	8000	810	60	100	800
	7800	810	62	103	780
	7600	810	63	105	760
	7400	810	65	108	740
	7200	810	67	111	720
	7000	810	69	114	700
	6800	810	71	118	680
	6600	810	73	121	660
	6400	810	75	125	640
	6200	810	77	129	620
	6000	810	80	133	600
	5800	773	80	133	600
	5600	747	80	133	600
	...	...	...	...	...
	600	80	80	133	600

**810W, 200-480Vac Input, Long Life High Quality Driver**

Model	Typical Set Output Current (mA)	Max Output Power (W)	Output Voltage Min (V)	Output Voltage Max(V)	Minimum Dimming Current (mA)
-C600	6000	810	80	133	600
	5800	810	83	138	580
	5600	810	86	143	560
	5400	810	89	148	540
	5200	810	92	154	520
	5000	810	96	160	500
	4800	810	100	167	480
	4600	810	104	174	460
	4400	810	109	182	440
	4200	810	114	190	420
	4000	762	114	190	420
	3800	724	114	190	420
	3600	686	114	190	420
	...	...	...	...	...
	420	80	114	190	420

Model	Typical Set Output Current (mA)	Max Output Power (W)	Output Voltage Min (V)	Output Voltage Max(V)	Minimum Dimming Current (mA)
-C420	4200	810	114	190	420
	4100	810	117	195	410
	4000	810	120	200	400
	3900	810	123	205	390
	3800	810	126	211	380
	3700	810	130	216	370
	3600	810	133	222	360
	3500	778	133	222	360
	3400	756	133	222	360
	3300	733	133	222	360
	3200	711	133	222	360
	3100	689	133	222	360
	3000	667	133	222	360
	2900	644	133	222	360
	2800	622	133	222	360
	2700	600	133	222	360
	...	...	...	...	...
	360	80	133	222	360

**■ Revision History**

Revision	Date	Contents
A	2022-06-28	1. First Release